

Linear Measuring Technology

Linear magnetic measurement system

Linear magnetic measurement system **LIMES LI50/B2**



High IP



Temperature range



Shock/vibration resistant



Reverse polarity protection

Robust

- **Increased ability to withstand vibrations and rough installation**

Eliminates machine downtime and repairs
High shock and vibration resistance, thanks to non-contact technology.

- **Stays sealed even when subjected to harsh everyday use. Offers security against failures in the field.**

Solid housing with up to IP 67 protection.



Compact

- **Installation depth only 10 mm, width of magnetic band 10 mm**
- **Installation height only 28 mm**
Can be used even where space is very tight

Simple installation

- **Fast start-up of the measuring system**
Easy fixing of the magnetic band and the sensor head
- **Easy mounting with large tolerances possible**
Distance of sensor head to magnetic band from 0.1 to 2.0 mm
Tolerates lateral misalignment + 1 mm
Warning signal when magnetic field is too weak (LED)

Technical data magnetic sensor **LIMES LI50:**

Output circuit:	Push-Pull	RS422
Supply voltage:	4,8 ... 30 V DC	4,8 ... 26 V DC
Load/channel, max cable length:	±20 mA, max. 30 m	120 Ohm, RS422 standard
Current consumption (without load):	typ. 25 mA, max. 60 mA	
Short circuit proof outputs ¹⁾ :	yes	yes ²⁾
Min. Pulse interval:	1 µs (edge interval) corresponds to 4 µs/cycle (see signal figures below)	
Output signal:	A, \bar{A} , B, \bar{B} , I, \bar{I}	
Reference signal:	Index periodical	
System Accuracy:	typ. ± 200 µm, max. ± (0.06 + 0.04 x L) mm, (L [m] up to L = max. 50 m, at T = 20 °C)	
Repeat accuracy:	±1 increment	
Resolution and speed ³⁾ :	25 µm (quadruple), max. 16.25 m/s 5 µm (quadruple), max. 3.25 m/s	
Permissible alignment tolerance	see draft "Mounting tolerances"	
Gap sensor / magnetic band:	0.1 ... 2.0 mm (1.0 mm recommended)	
Offset:	max. ±1 mm	
Tilting:	max. 3 °	
Torsion:	max. 3 °	
Working temperature:	-20 ... +80 °C	
Shock resistance:	500g/1 ms	
Vibration strength:	30 g/10 ... 2000 Hz	
Protection class:	IP 67 according to DIN 60 529 (housing)	
Humidity:	100 %, condensation possible	
Housing:	Zinc die-cast	
Cable:	2 m, PUR 8 x 0,14 mm ² , shielded, may be used in trailing cable installations	
Status-LED:	Green: Pulse-index; Red: Error Speed too high or magnetic fields too weak (for sensors 8.LI50.XXXX.X050 and 8.LI50.XXXX.X250)	
CE-compliant according to:	EN 61 000-6-2, EN 61 000-6-4, EN 61 000-6-3 EN 61 000-4-8 (magnetic field)	
RoHS compliant acc. to EU guideline 2002/95/EG		

Function principle:

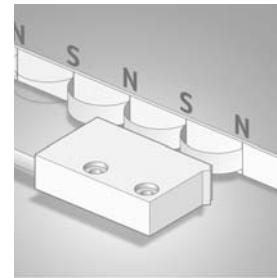

Signal figures

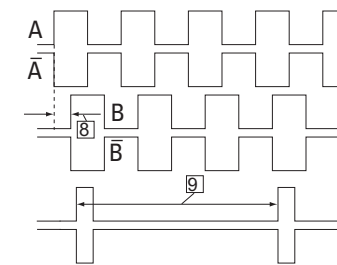

- ⁹⁾ periodic index signal (every 2 mm)
The logical assignment A, B and I-Signal can change
- ⁸⁾ Min. Pulse interval: pay attention to the instructions in the technical data

¹⁾ With supply voltage correctly applied

²⁾ A max. of one channel only may be short-circuited: (when UB=5 V, a short circuit to another channel, 0 V, or +UB is permissible.) (when UB=5-30 V, a short circuit to another channel or to 0 V is permissible.)

³⁾ At the listed rotational speed the min. pulse interval is 1 µs, this corresponds to 250 kHz. For the max. rotational speed range a counter with a count input frequency of not less than 250 kHz should be provided.

Linear magnetic measurement system **LIMES LI50/B2**

Technical data magnetic band **LIMES B2:**

Pole gap:	5 mm from pole to pole
Dimensions:	Width: 10 mm, Thickness: 1.7 mm incl. masking tape
Temperature coefficient:	$(11 \pm 1) \times 10^{-6} / K$
Temperature ranges:	working temperature: $-20 \dots +80 \text{ }^\circ\text{C}$ storage temperature: $-40 \dots +80 \text{ }^\circ\text{C}$
Mounting:	adhesive joint
Measuring:	0,1 m (to receive an optimal result of measurement, the magnetic band should be ca. 0.1 m longer than the desired measuring length)
Bending radius:	$\leq 50 \text{ mm}$

Dimensions:

Magnetic sensor **LIMES LI50:**

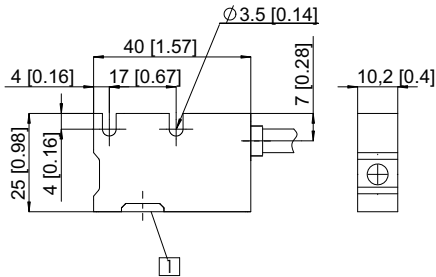

1 active measuring area

Pin assignment:

Signal	Wire colour
0 V, GND	white
U_B	brown
A	green
\bar{A}	yellow
B	grey
\bar{B}	pink
I	blue
\bar{I}	red

Shield is on the housing



Permissible Mounting tolerances:

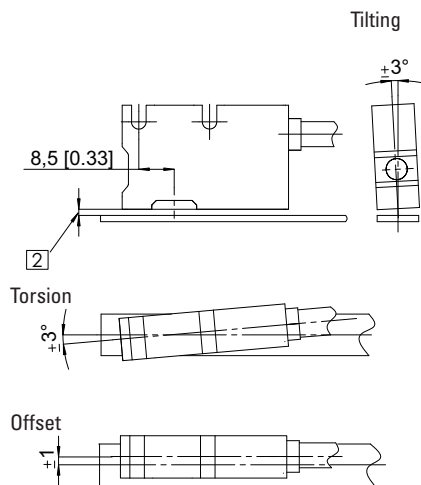

2 Distance Sensor / Magnetic band:
0.1... 2.0 mm (1 mm recommended)

Magnetic band **LIMES B2:**

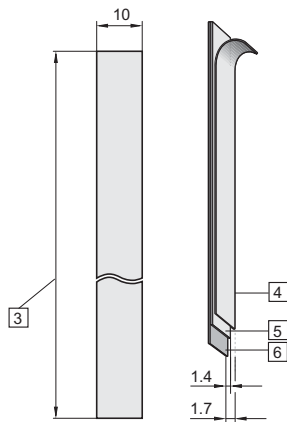

- 3 length L, max. 50 m
- 4 masking tape
- 5 magnetic band
- 6 carrier band

Linear magnetic measurement system **LIMES LI50/B2**

Order code magnetic sensor **LIMES LI50:**

8.LI50.11X1.2XXX

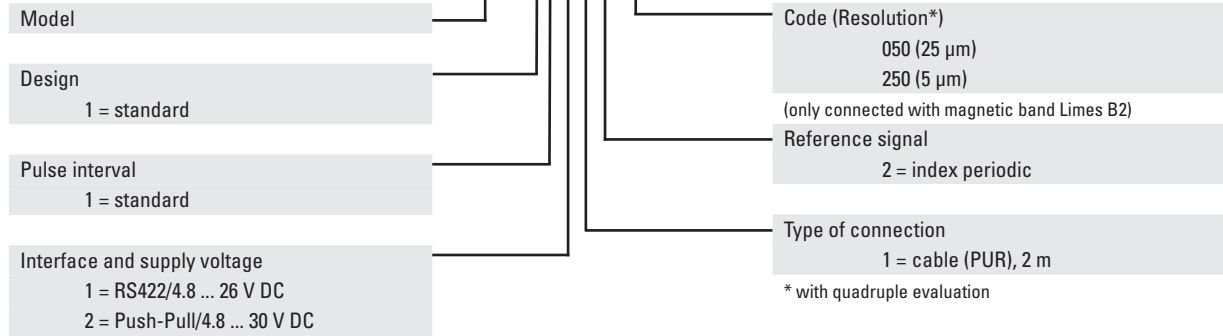

Standard stock types:	
8.LI50.1111.2050	8.LI50.1121.2050
8.LI50.1111.2250	8.LI50.1121.2250

Order code magnetic band **LIMES B2:**

8.B2.10.010.XXXX

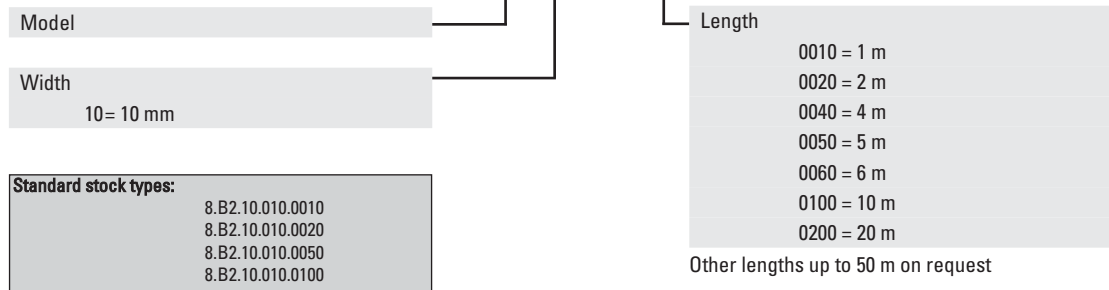

Standard stock types:	
8.B2.10.010.0010	
8.B2.10.010.0020	
8.B2.10.010.0050	
8.B2.10.010.0100	

Display Type 572 for **LIMES LIxx:**



Counter series for demanding applications, with two individually scalable encoder inputs. HTL or TTL in each case A, \bar{A} , B, \bar{B} for count frequencies up to 1 MHz per channel. Operating modes can be selected for position or event counter, total counter, difference counter, cut-to-length display, diameter calculator, batch counter and more.

- 2 separate freely scalable count inputs - HTL or TTL; also with inverted inputs
- Max. input frequency 1 MHz/ channel
- 4 freely programmable fast solid-state outputs, each with 350 mA output current
- Step or tracking preset
- AC and DC supply voltage
- Can be used as a counter or position display with limit values
- Monitoring function, where 2 values are monitored or calculated with respect to each other
- 4 fast programmable inputs with various functions such as reset, gate, display memory, reference input or switching between the display values.
- Optional scalable analogue output 0/4 ... 20 mA, +/-10 V or 0 ... 10 V

- 2 auxiliary power supplies for sensors: 5.2 V DC and 24 V DC
- Standard interface RS 232

- Order code specification:**
- Position display, 6 digits**, with 4 fast switch outputs and serial interface:
6.572.0116.D05
- Position display, 6 digits**, with 4 fast switch outputs and serial interface and scalable analogue output:
6.572.0116.D95
- Position display, 8 digits**, with 4 fast switch outputs and serial interface:
6.572.0118.D05
- Position display, 8 digits**, with 4 fast switch outputs and serial interface and scalable analogue output:
6.572.0118.D95